

# SHARP®

## ROOM AIR CONDITIONER INSTALLATION AND OPERATION MANUAL



This **INSTALLATION AND OPERATION MANUAL** explains the proper use of your new Sharp Air Conditioner. Read these instructions carefully before installing or operating your air conditioner. The **INSTALLATION AND OPERATION MANUAL** should be kept in a safe place for handy reference.

As an **ENERGY STAR** Partner, Sharp Electronics has determined that this product (AF-Q60RX, AF-Q80RX) meets the **ENERGY STAR** guidelines for energy efficient air conditioners. To meet these guidelines, air conditioners must be at least 10% more efficient than the minimum Federal standard.

**AF-Q60RX**



**AF-Q80RX**



<b>CONTENTS</b>	<b>PAGE</b>
<b>FOR YOUR PROTECTION</b> .....	2
<b>CONSUMER LIMITED WARRANTY</b> .....	3
<b>INSTALLATION INSTRUCTIONS</b>	
● CHECK WINDOW AREA .....	4
● LOCATION .....	4
● ACCESSORIES .....	5
● SUGGESTED TOOLS .....	5
● INSTALLATION .....	6
<b>PRECAUTIONS</b>	
● CAUTION FOR USE .....	9
● GROUNDING INSTRUCTIONS .....	9
● NOTES ON OPERATION .....	10
● ENERGY EFFICIENCY TIPS .....	10
<b>HOW TO OPERATE</b>	
● PARTS NAMES .....	11
● TO TURN UNIT ON .....	12
● TO CHANGE TEMPERATURE SETTING .....	13
● TO ADJUST FAN SPEEDS .....	13
● TO USE AUTO COOL FEATURE .....	13
● TO OPERATE ON FAN .....	14
● TO USE ENERGY SAVE FEATURE .....	14
● TIMER FEATURE .....	14
● TO TURN UNIT OFF .....	15
● TO CHANGE AIR FLOW DIRECTION .....	15
● USING THE REMOTE CONTROLLER .....	16
<b>CLEANING AND MAINTENANCE</b> .....	17
<b>BEFORE CALLING FOR SERVICE</b> .....	18
● FAULT CODES .....	19

# FOR YOUR PROTECTION

To aid in answering questions if you call for service or for reporting loss or theft, please record below the model and serial number located on the right side of the unit.

---

**MODEL NUMBER**

---

**SERIAL NUMBER**

---

**DATE OF PURCHASE**

---

**Dealer Name**

---

**Address**

---

**City**

---

**State**

---

**Zip**

---

**Telephone**

---

**TO PHONE:** Dial 1-800-BE-SHARP (237-4277) for:  
SERVICE (for your nearest Sharp Authorized Servicer)  
PARTS (for your Authorized Parts Distributor)  
ACCESSORIES  
ADDITIONAL CUSTOMER INFORMATION

**TO WRITE:** For service problems, warranty information, missing items and other assistance:  
Sharp Electronics Corporation  
Customer Assistance Center  
1300 Naperville Drive  
Romeoville, IL 60446-1091

Please provide the following information when you write or call: model number, serial number, date of purchase, your complete mailing address (including zip code), your daytime telephone number (including area code) and description of the problem.

# CONSUMER LIMITED WARRANTY

## CONSUMER LIMITED WARRANTY

SHARP ELECTRONICS CORPORATION warrants to the first consumer purchaser that this Sharp brand product (the "Product"), when shipped in its original container, will be free from defective workmanship and materials, and agrees that it will, at its option, either repair the defect or replace the defective Product or part thereof with a new or remanufactured equivalent at no charge to the purchaser for parts or labor for the period(s) set forth below.

This warranty does not apply to any appearance items of the Product nor to the additional excluded item(s) set forth below nor to any Product the exterior of which has been damaged or defaced, which has been subjected to improper voltage or other misuse, abnormal service or handling, or which has been altered or modified in design or construction.

In order to enforce the rights under this limited warranty, the purchaser should follow the steps set forth below and provide proof of purchase to the servicer.

The limited warranty described herein is in addition to whatever implied warranties may be granted to purchasers by law. **ALL IMPLIED WARRANTIES INCLUDING THE WARRANTIES OF MERCHANTABILITY AND FITNESS FOR USE ARE LIMITED TO THE PERIOD(S) FROM THE DATE OF PURCHASE SET FORTH BELOW.** Some states do not allow limitations on how long an implied warranty lasts, so the above limitation may not apply to you.

Neither the sales personnel of the seller nor any other person is authorized to make any warranties other than those described herein, or to extend the duration of any warranties beyond the time period described herein on behalf of Sharp.

The warranties described herein shall be the sole and exclusive warranties granted by Sharp and shall be the sole and exclusive remedy available to the purchaser. Correction of defects, in the manner and for the period of time described herein, shall constitute complete fulfillment of all liabilities and responsibilities of Sharp to the purchaser with respect to the Product, and shall constitute full satisfaction of all claims, whether based on contract, negligence, strict liability or otherwise. In no event shall Sharp be liable, or in any way responsible, for any damages or defects in the Product which were caused by repairs or attempted repairs performed by anyone other than an authorized servicer. Nor shall Sharp be liable or in any way responsible for any incidental or consequential economic or property damage. Some states do not allow the exclusion of incidental or consequential damages, so the above exclusion may not apply to you.

THIS WARRANTY GIVES YOU SPECIFIC LEGAL RIGHTS. YOU MAY ALSO HAVE OTHER RIGHTS WHICH VARY FROM STATE TO STATE.

<b><u>Your Product Model Number &amp; Description:</u></b>	AF-Q60RX, AF-Q80RX Room AirConditioner. Be sure to have this information available when you need service for your Product.
<b><u>Warranty Period for this Product:</u></b>	One (1) year parts and labor from date of purchase. The warranty period continues for a total of five (5) years from date of purchase for the Sealed Cooling System parts; labor and service are not provided free of charge for this additional period.
<b><u>Additional Item(s) Excluded From Warranty Coverage (If any):</u></b>	Appearance items of the Product, remote control, filter, or accessories, mounting kit, seals, or any printed materials. Product which has been used for rental and/or commercial purposes
<b><u>Where to Obtain Service:</u></b>	From a Sharp Authorized Servicer located in the United States. To find the location of the nearest Sharp Authorized Servicer, call Sharp Toll Free at 1-800-BE-SHARP.
<b><u>What to Do to Obtain Service:</u></b>	Contact your Sharp Authorized Servicer to obtain in-home service for this Product. The Servicer will come to your home, and if it is necessary to remove the Product, the Servicer will reinstall it. Be sure to have Proof of Purchase available.

TO OBTAIN SUPPLY, ACCESSORY OR PRODUCT INFORMATION, GO TO OUR WEBSITE AT [www.sharpsusa.com](http://www.sharpsusa.com)  
OR CALL 1-800-BE-SHARP.

# SHARP®

## SHARP ELECTRONICS CORPORATION

Sharp Plaza, Mahwah, New Jersey 07495-1163

# INSTALLATION INSTRUCTIONS

Before beginning installation, read these instructions carefully.  
Use the enclosed MOUNTING KIT for proper installation.

## CHECK WINDOW AREA

The mounting kit is designed for wooden sill double or single hung sash-type windows.

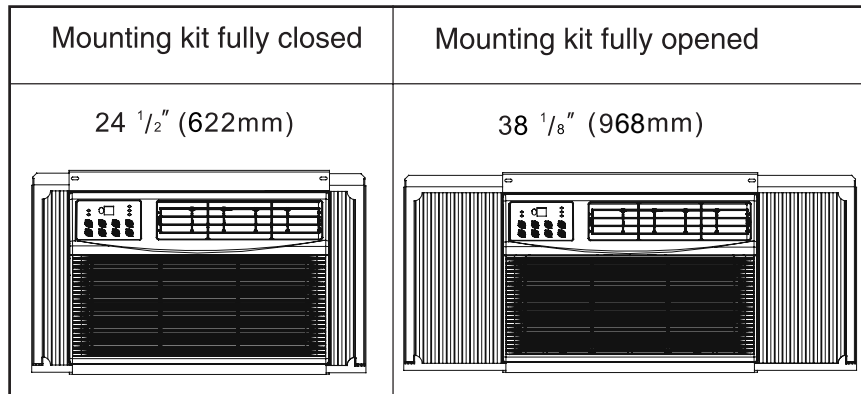

Window opening from stool to lower sash bottom must be 13 5/8" (346mm) or more.

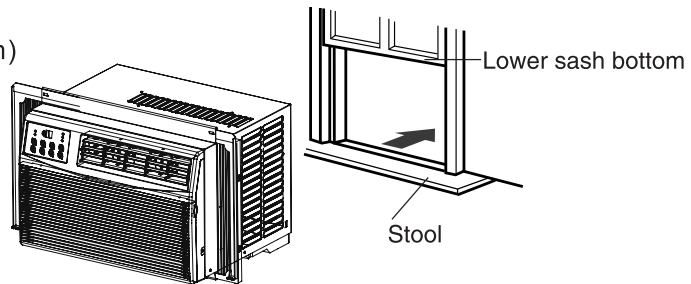

## LOCATION

- The air conditioner should be installed in a solid window to minimize noise and vibration. For safe installation, repairs, replacement and secure positioning, make sure the window is solid and level.
- The room air conditioner must be installed in an area within reach of a properly rated grounded outlet.
- Use of extension cords of any kind is not recommended.
- Never place any obstacles around the air inlet.

# INSTALLATION INSTRUCTIONS

## ACCESSORIES

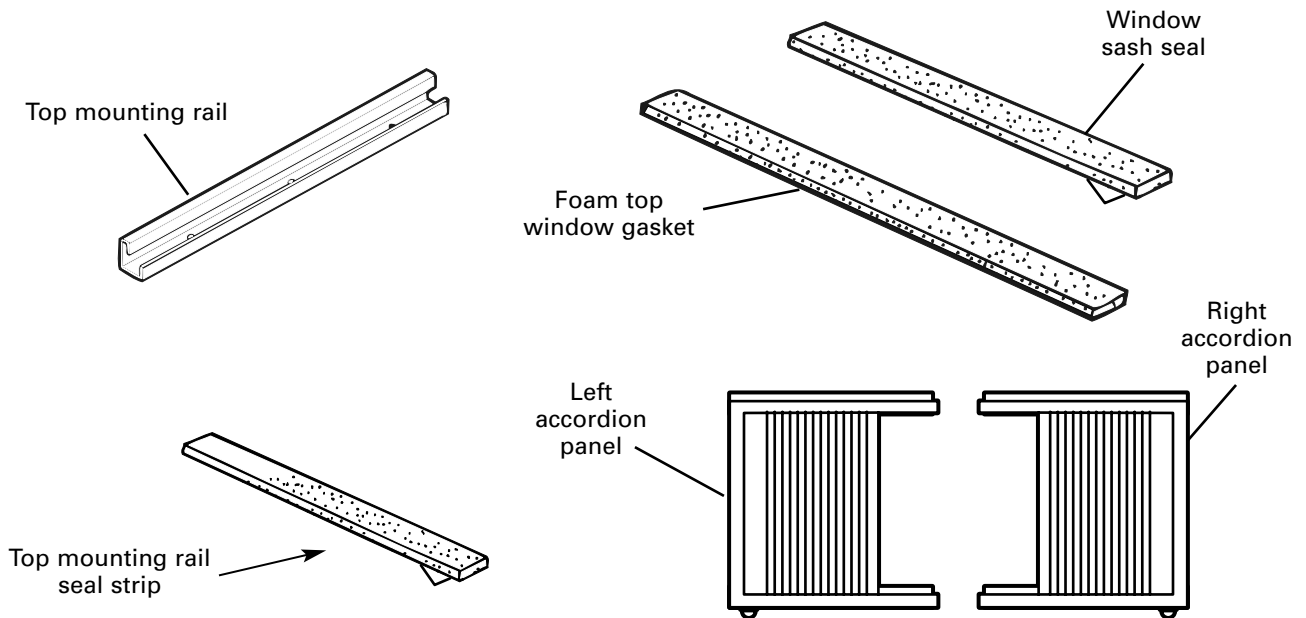

Type A (6)



Type B (3)

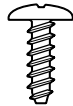

Type C (5)



Window locking bracket (1)

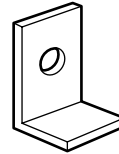

Remote Control



## SUGGESTED TOOLS

1. Screw driver (medium size Phillips)
2. Tape measure or ruler
3. Knife or scissors

# INSTALLATION INSTRUCTIONS

## INSTALLATION

**WARNING: Make sure the unit is turned off and unplugged before installing.**

- 1 Cut the window sash foam seal (adhesive type) to the proper length and attach it to the underside of the window sash.

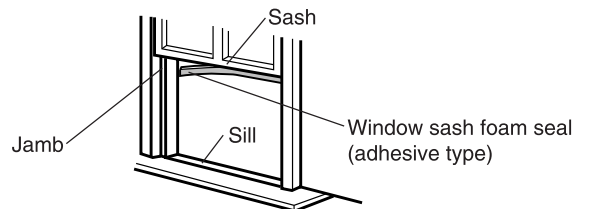

- 2 Remove the air conditioner from the case. Place the unit on floor, a bench or a table.

Use protective material to prevent damage to the surface.

- A. Remove the backing from the top mounting rail seal strip and attach the seal strip to the bottom of the top mounting rail, along the front edge. See FIG 1.

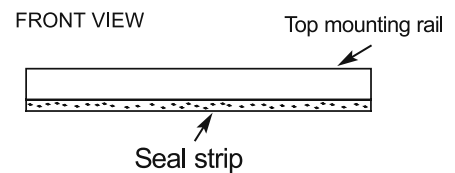
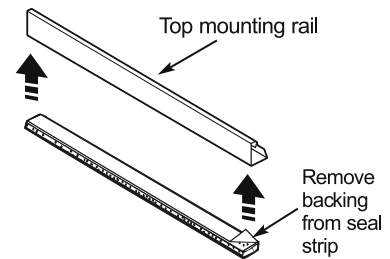

FIG 1

- B. Align the holes in the top rail with those in top of the unit as shown in FIG. 2A  
The higher flange should be toward the front of the air conditioner.

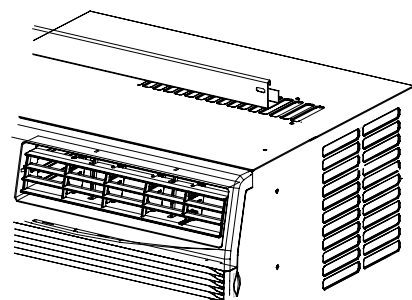

FIG. 2A

- C. Secure the top rail to the unit with 3  $\frac{3}{8}$ " (9.5mm) Type B Screws as shown in FIG 2B.

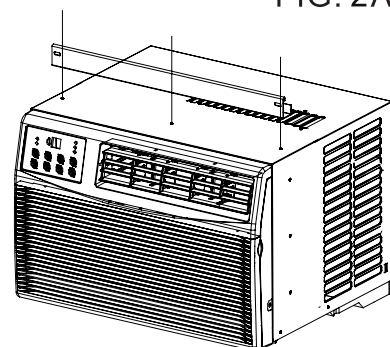

FIG. 2B

# INSTALLATION INSTRUCTIONS

**NOTE:** Top Rail and Sliding Panels at each side are offset to provide the proper pitch to the rear of the unit. This is necessary for proper condensed water utilization and drainage. If you are not using the Side Panels for any reason, this pitch to the rear must be maintained!

**3** There is a Left and Right Window Filler Panel-be sure to use the proper panel for each side. When installed the flange for securing the panel to the window sill will be facing into the room.

A. Hold the Accordion Panel in one hand and gently pull back the panel beyond the ends of the frame. See FIG. 3.

**FIG.3**

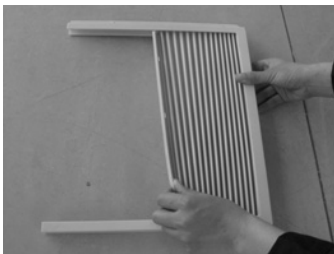

B. Slide the left and right accordion panels into the top and bottom mounting rails. See FIG.4.

**FIG.4**



C. Attach the accordion panels to the case using 3 1/4" (6.5mm) Type A screws on each side. FIG.5A, FIG.5B & FIG.11.



**FIG.5A**

**FIG.5B**



NOTE: If storm window blocks AC, see FIG. 11

**4** Keep a firm grip on the air conditioner, carefully place the unit into the window opening so the bottom of the air conditioner frame is against the window sill (FIG.6). Carefully close the window behind the top rail of the unit.



**FIG. 6**

**5** Extend the side panels out against the window frame (FIG.7).



**FIG.7**

**6** Drive 4 3/4" (19mm) Type C locking screws through frame holes into window sash (FIG.8A and FIG.8B).

**FIG.8A**

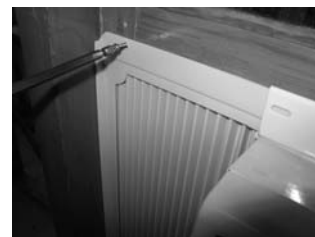

**FIG.8B**



## INSTALLATION INSTRUCTIONS

- 7** To secure lower sash in place, attach right angle window lock with 3/4" (19 mm) Type C screw as shown (FIG. 9).

FIG.9



- 8** Cut foam seal and insert in the space between the upper and lower sashes (FIG.10).

FIG.10



### If AC is Blocked by Storm Window

Add wood as shown in FIG.11, or remove storm window before air conditioner is installed.

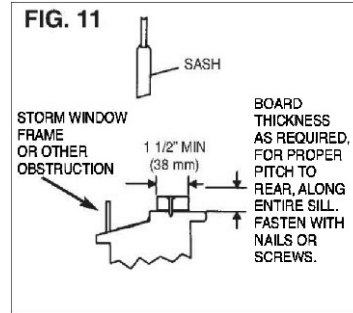

If Storm Window Frame must remain, be sure the drain holes or slots are not caulked or painted shut. Accumulated Rain Water or Condensation must be allowed to drain out.

### Removing AC From Window

- \* Turn AC off, and disconnect power cord.
- \* Remove sash seal from between windows, and unscrew safety lock.
- \* Remove screws installed through frame
- \* Close(slide) side panels into frame.
- \* Keeping a firm grip on air conditioner, raise sash and carefully "rock" air conditioner backward to drain any condensate water in base of unit. Be careful not to spill any remaining water while lifting unit from window. Store parts WITH air conditioner.



# PRECAUTIONS

## CAUTION FOR USE

**IMPORTANT:** Points to keep in mind when using your air conditioner.

- **Install the air conditioner by following the installation instructions given in the previous section of this manual.**
- **Make sure the unit is the correct capacity for the area you want to cool.**
- **Do not modify any part of this product.**
- **Do not insert objects into any part of the unit.**
- **Push the AC power plug securely into the receptacle and make sure it is not loose.**
- **Use power circuit with a proper voltage rating.**  
Use a three-pronged grounded electrical outlet rated 125V, 60Hz, 15 amp or more, AC only as shown on right.  
Use of an improper voltage rating power circuit can result in damage to the unit and possibly fire.
- **Always use a fuse with the proper amp rating.**  
Do not, under any circumstances, use wire, pins or other objects in place of the proper fuse.
- **Use of extension cords of any kind is not recommended.**  
If you still elect to use an extension cord, it is absolutely necessary that it be a UL Listed 3-wire grounding type appliance extension cord rated 125 Volts, 15 amp or more.
- **Ventilate the room periodically during use, especially if using gas appliances.**

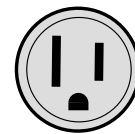

3-Pronged Grounding Receptacle 15 Amps. 125V.

## GROUNDING INSTRUCTIONS

**WARNING: Improper use of the grounding plug can result in the risk of electric shock.**

This appliance must be grounded. In the event of an electrical short circuit, grounding reduces the risk of electric shock by providing an escape wire for the electric current.

This appliance is equipped with a cord having a grounding wire with a grounding plug.

The plug must be plugged into an outlet that is properly installed and grounded.

**WARNING: Do not under any circumstances cut or remove the round grounding prong from this plug.**

If it is necessary to use an extension cord, use only a UL Listed 3-wire extension cord that has a 3-blade grounding plug, and a 3-slot receptacle that will accept the plug on the appliance.

The marked rating of the extension cord should be AC 125 Volt, 15 Amp or more.

Consult a qualified electrician or serviceman if the grounding instructions are not completely understood, or if doubt exists as to whether the appliance is properly grounded.

If a grounding adapter is used, make sure the receptacle box is fully grounded.

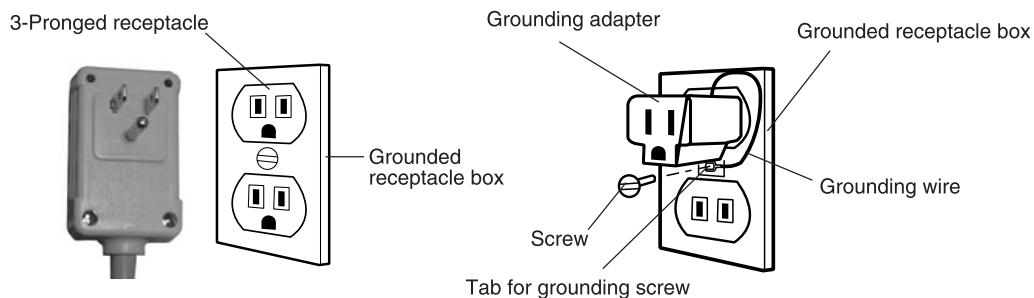

## PRECAUTIONS

### NOTES ON OPERATION

- **Allow 3 minutes for the compressor to restart cooling.**  
If you turn the air conditioner off and immediately restart it, allow three minutes for the compressor to restart cooling. There is an electronic device in the unit that keeps the compressor off for three minutes.
- **When power failure occurs**  
This air conditioner has a memory function to store settings when a power failure occurs. After power recovery, the unit will automatically re-start in the same settings which were active before the power failure.
- **Dehumidifying function**  
The air conditioner removes moisture from the air in your room.
- **Cooling operation under low temperatures: Is your unit freezing up?**  
The unit operates on inside and outside temperatures. Freezing can occur when the temperature is set close to 64°F and when there are low outside temperatures, especially during the night hours. At these conditions, a further temperature drop may cause the unit to freeze. Setting the unit to a higher temperature will prevent it from freezing.

### ENERGY EFFICIENCY TIPS

- **Setting the proper temperature.**  
For optimum energy efficiency, keep the difference between the inside and outside temperature within 10°F(5°C). Do not keep the temperature setting any lower than is necessary for you to feel comfortable. Generally, 78°F to 80°F(26°C to 27°C) is a comfortable summer indoor temperature.  
When you turn the unit on, do not set the temperature higher than the room temperature at start up as this will not allow the compressor to cycle and maintain a comfortable room temperature.
- **Avoid direct sunlight.**  
Close blinds, drapes or shades to keep out direct sunlight during cooling operation.
- **Keep the filter clean.**  
Keeping the filter clean greatly aids efficient operation. A dirty filter blocks the flow of air, making your air conditioner work harder and less efficiently. See page 17 on how to clean the filter.
- **Turn off unnecessary lights.**  
Your air conditioner must remove the heat produced by your lights or other heat-producing appliances. Turn off lights or appliances that are not in use.
- **Install your air conditioner in a shady location.**  
Direct sunlight on a window air conditioner increases its workload and will increase its operating cost.
- **Don't let cool air escape.**  
Close windows and outside doors. Do not keep doors open and let hot air rush in. Improperly installed air conditioners and improperly weatherstripped doors and windows will let hot air in and the cool air out.
- **Turn off air conditioner when no one is home.**  
Use only when necessary. The fewer hours a room air conditioner is used, the lower the operating cost.

# HOW TO OPERATE

## PARTS NAMES

### UNIT

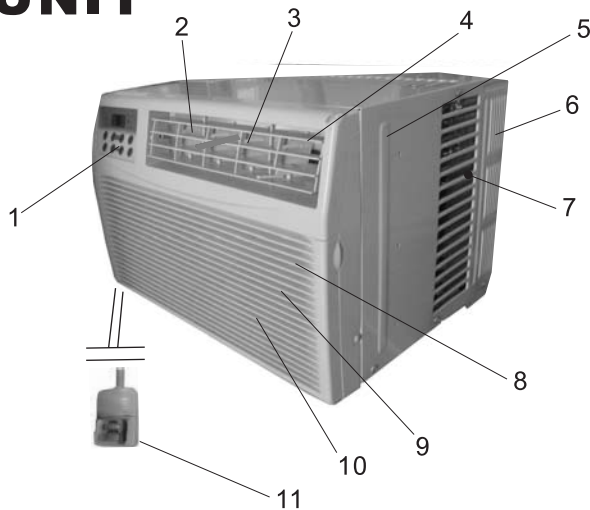

1. Control panel
2. Air outlet (Indoor Side)
3. Vertical louvers
4. Horizontal louvers
5. Cabinet
6. Air outlet (Outdoor Side)
7. Air inlet (Outdoor Side)
8. Air filter (Open the front panel to remove)
9. Front panel
10. Air inlet (Indoor side)
11. Power cord

## CONTROL PANEL

The display always shows the set temperature except when setting the Delay timer

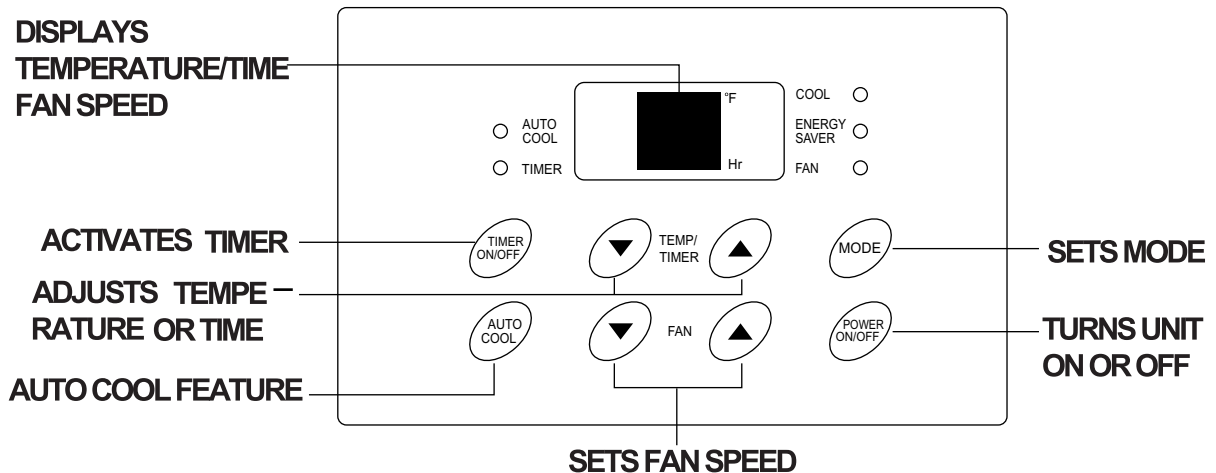

## Touch Pad

# HOW TO OPERATE

Before you begin, thoroughly familiarize yourself with the control panel and remote as shown below and all its functions, then follow the symbol for the functions you desire. **The unit can be controlled by the touch pad alone or with the remote.**

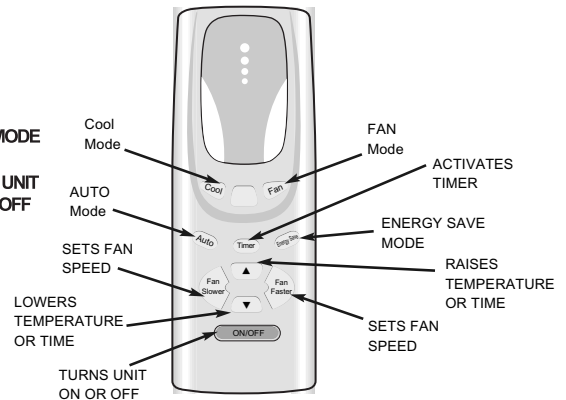
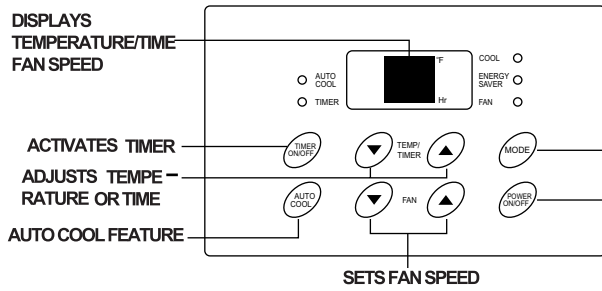

Remote Control

**NOTE:** The following instructions represent the Touch Pad, the same instructions can be used for the Remote Control.

**TO TURN UNIT ON:**

**YOU WILL SEE:**

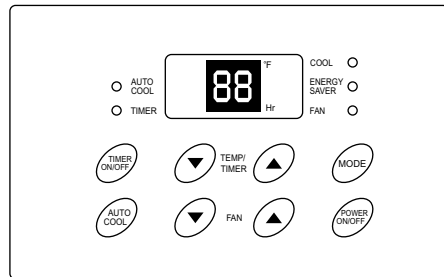
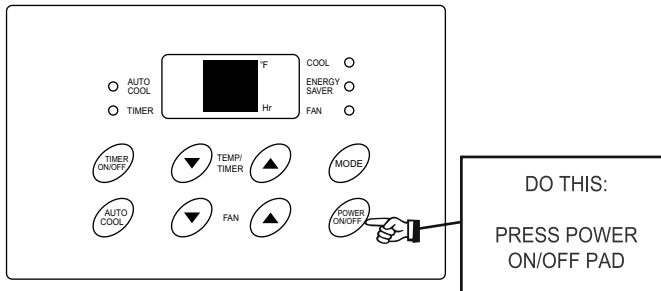

# HOW TO OPERATE

## TO CHANGE TEMPERATURE SETTING:

## YOU WILL SEE:

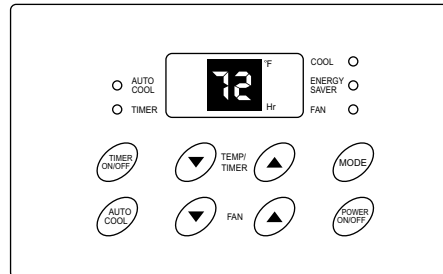
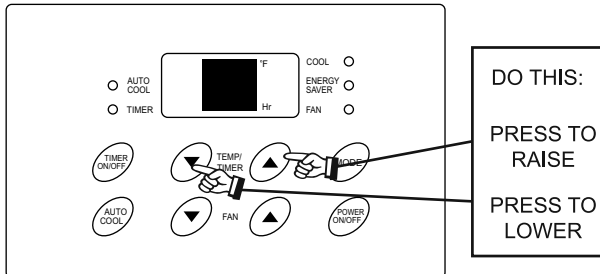

Note: Tap or hold either up (▲) or down (▼) button until the desired temperature is seen on the display. This temperature will be automatically maintained anywhere between 60°F (16°C) and 90°F (32°C). If you want the display to read the actual room temperature See "To Operate on Fan" section .

## TO ADJUST FAN SPEEDS:

## YOU WILL SEE:

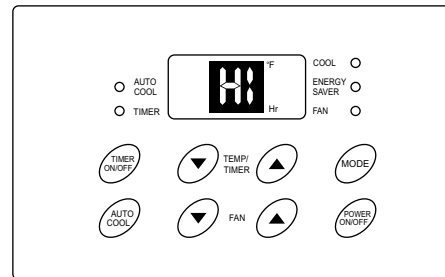
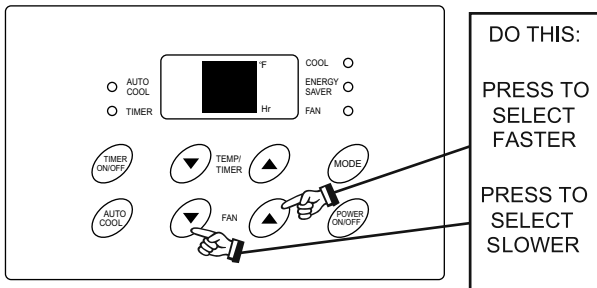

Press the Fan Faster button (▲) will increase the fan speed from Low (LO), to Medium (ME), to High (HI). The digital display will indicate your chosen speed. Press the Fan Slower button (▼) will decrease the fan speed from High (HI), to Medium (ME), to Low (LO). The digital display will indicate your chosen speed. After 5 seconds the display will revert back to the set temperature.

## TO USE AUTO COOL :

## YOU WILL SEE: LIGHT ON

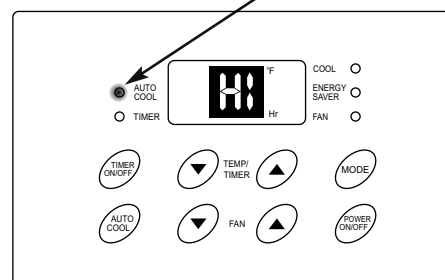
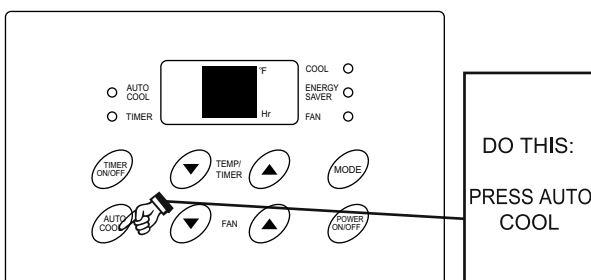

Note: Fan starts at High Speed and adjusts to a slower speed as the room temperature dictates. For example if the room doesn't get too warm, it will stay at the slowest speed. If the room temperature rises quickly, such as a door being opened, it will automatically go to the highest speed. The fan speeds will re-adjust back to the slowest speed as the room returns to the original set temperature. Press either the fan slower (▼) or fan faster button (▲) to adjust the fan speed manually.

# HOW TO OPERATE

## TO OPERATE ON FAN:

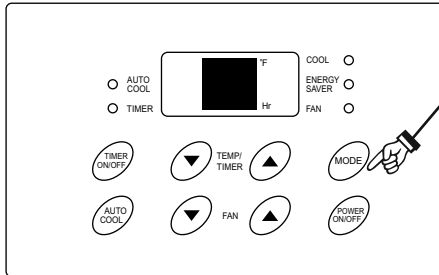

DO THIS:  
PRESS MODE  
BUTTON  
CHOOSE  
FAN

## YOU WILL SEE: LIGHT ON

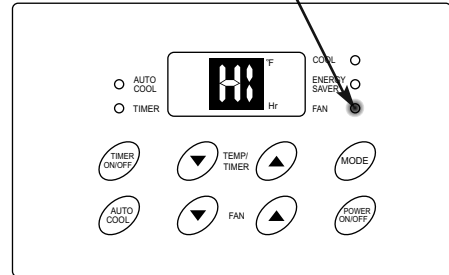

Note: Use this function only when cooling is not desired, such as for room air circulation. You can choose any fan speed you prefer.  
During this function, the display will show the actual room temperature, not the set temperature as in the cooling mode.

## TO USE THE ENERGY SAVE:

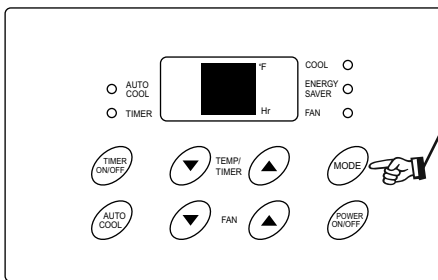

DO THIS:  
PRESS MODE  
BUTTON  
CHOOSE  
ENERGY  
SAVE

## YOU WILL SEE:

LIGHT ON

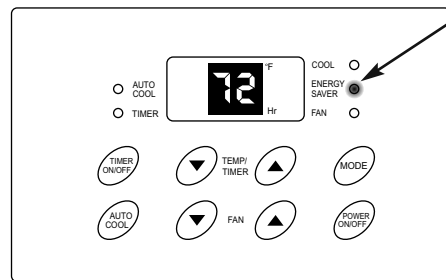

Note: In this mode, the fan will continue to run for 3 minutes after the compressor shuts off. The fan then cycles on for 2 minutes at 10 minute intervals until the room temperature is above the set temperature, at which time the compressor turns back on and cooling starts.

## TIMER:TIMER ON/OFF

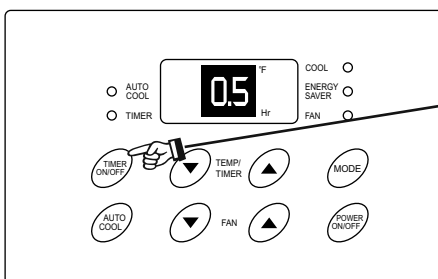

DO THIS:  
PRESS TIMER  
BUTTON

## YOU WILL SEE: LIGHT ON

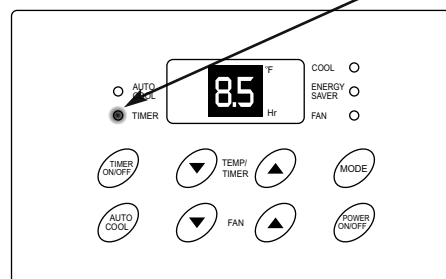

Note: For Timer Off, the unit must be in the On position.  
Note: For Timer On, the unit must be in the Off position.

To adjust timer setting, tap or hold the UP arrow(▲) or the DOWN arrow(▼) to change delay timer at 0.5 hour increments, up to 10 hours, then at 1 hour increments up to 24 hours. The control will count down the time remaining until start (8, 7.5, 7, etc.). The Timer On mode automatically selects cooling with maximum Fan Speed. The temperature maintained will be the same as previously set. To change the set temperature, press "MODE" then Up or Down arrows until the desired temperature is indicated on the display. After 5 seconds, the control will automatically change the display back to the hours remaining until the unit will start/stop. Turning the unit "ON" or "OFF" at any time will cancel the Timer

14

On/Off function.  
The Timer On/Off Feature will work until the unit either starts or stops. Once that happens the above steps have to be repeated again.

## TO TURN UNIT OFF:

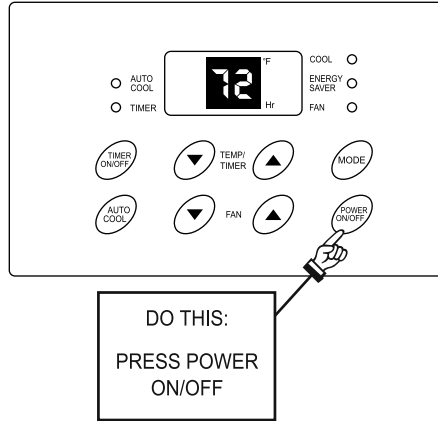

## TO CHANGE AIR FLOW DIRECTION

The horizontal louvers are used to adjust the UP/DOWN direction of air flow, and the vertical louvers are used to adjust the LEFT/RIGHT direction of air flow for uniform and efficient cooling of the room.

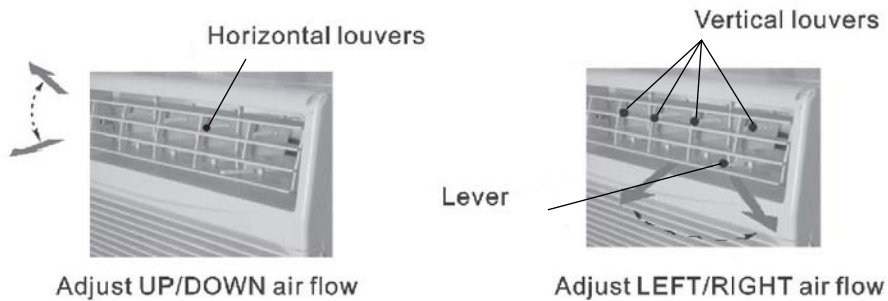

## HOW TO OPERATE

### USING THE REMOTE CONTROL

#### INSTALLING BATTERIES

Use two size-AAA (R03) batteries.

- 1 Open the battery compartment cover.
- 2 Insert and slide the batteries into the compartment, making sure the  $\oplus$  and  $\ominus$  polarities are properly aligned.
- 3 Close the cover.

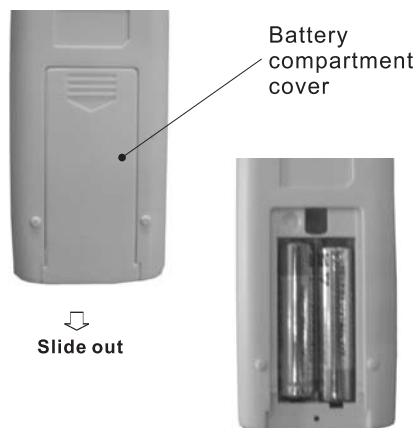

#### NOTES:

- The battery life is approximately one year with normal use.
- When you replace the batteries, always use two new ones of the same type.
- If the remote control does not operate normally after replacing the batteries, take out the batteries and replace them again after 30 seconds.
- If you will not be using the unit for a long time, remove the batteries from the remote control.

#### HOW TO USE THE REMOTE CONTROL

Point the remote control towards the unit's receiver window and press the desired button. A beep will sound when the unit receives the signal.

- Make sure no objects, such as curtains, block the receiver window.
- The remote control operates from up to 20 feet (6 meters) away.
- The beep will also sound when each pad on the control panel is touched.



#### CAUTION:

- Do not expose the receiver window to direct sunlight. This can adversely affect its operation. In such case, close the curtains to block the sunlight.
- Use of a fluorescent lamp in the same room may interfere with the transmission of the signal.
- The unit may be affected by signals emitted from the remote control of a television, VCR or other equipment used in the same room.
- Do not leave the remote control exposed to direct sunlight or near a heater. Protect the remote control from moisture and shock which can discolor or damage it.



# CLEANING AND MAINTENANCE

## CLEANING THE FILTER

If the filter is clogged with dust, the amount of air flow will be reduced, resulting in poor cooling performance. The filter should be cleaned every 10 days. At the beginning of every cooling season or after a long period of inactivity, clean the filter before starting the unit.

### 1 REMOVE THE FILTER

Open the front panel and get the filter out.



### 2 CLEAN THE FILTER

To remove dust from the filter, use a vacuum cleaner or wash it in clean water.

If the filter is very dirty, wash it with detergent and rinse carefully with clean water. Dry the filter with a soft cloth.

Do not expose the filter to heat or dry it in direct sunlight.

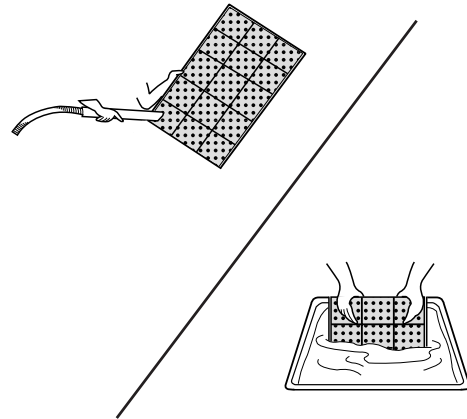

### 3 RE-INSTALL THE FILTER

Put the filter into its original position and close the front panel.

Never operate the unit without installing the filter. It may result in serious damage to the unit.

## CLEANING OF THE FRONT PANEL AND CABINET

To clean the front panel and cabinet, wipe with a soft, dry cloth or with a cloth moistened with a mild soap. Rinse carefully by wiping with a damp cloth and dry completely.

Avoid splashing the unit with water. Excess water can damage electrical insulation and result in danger.

Never use harsh chemicals or abrasive cleaners on any part of the unit. To avoid damage to the unit, do not use hot water (120°F / 50°C or more) when cleaning.

## OILING OF THE COMPRESSOR AND FAN MOTOR IS UNNECESSARY

The compressor is permanently lubricated and is hermetically sealed. The fan motor is lifetime sealed and does not require oiling.

## REMOVING THE AIR CONDITIONER

Before removing the air conditioner, operate the unit in the FAN mode with high fan speed on a dry day, for about half a day to thoroughly dry the water inside the air conditioner unit.

# BEFORE CALLING FOR SERVICE

**IF YOUR AIR CONDITIONER DOES NOT OPERATE PROPERLY, PLEASE CHECK THE FOLLOWING ITEMS BEFORE CALLING FOR SERVICE .**

## POWER PLUG CHECK

This air conditioner uses a fused power plug. Always check the power plug before use.

- 1 Press the RESET button.
- 2 Insert the power plug into the wall socket.
- 3 Press the TEST button.  
You will hear a CLICK if the circuit breaker is functioning correctly.
- 4 Press the RESET button until you hear another CLICK.

RESET  
TEST



The circuit breaker is activated, power is supplied, and the air conditioner is now ready for use.

Do not attempt to use the air conditioner if the above procedure is impossible, as it is malfunctioning.  
Disconnect the power plug and request a service.

## AIR CONDITIONER DOES NOT OPERATE AT ALL

- Is the unit plugged in or is the plug loose?
- Is the fuse blown or the circuit breaker tripped?
- Did you restart the unit within 3 minutes after a power failure? If the power was off for less than 3 minutes, and you restarted the air conditioner within 3 minutes, a protective device may cause the compressor to shut off, preventing cooling for about 5 minutes.

## AIR CONDITIONER DOES NOT PROPERLY COOL

- Is the MODE set to fan only Mode?  
Cooling will not take place in the fan only mode. Change the MODE setting.
- Is the filter clogged with dust?  
A dirty filter can cause the cooling coils to freeze. If this happens, clean the filter and replace. Run the air conditioner on the MED FAN setting until all ice dissipates.
- Is the temperature set properly?  
If your room is too warm, adjust the temperature setting lower.
- Is the window exposed to direct sunlight?  
Close curtains or blinds to minimize solar energy heating the room.
- Are the windows or doors open?  
Close all windows and doors for maximum cooling.

## BEFORE CALLING FOR SERVICE

### NOTE: WATER IN BOTTOM OF TRAY

- Water will collect in the bottom tray of the unit. This is normal. Water condenses on the evaporator coil at the front of the unit and is channeled to the rear where it is picked up by the condenser fan. The water is blown onto the condenser coil fins and this creates a "splashing" noise which is normal. If excess water builds up in this tray it will drain outside through a grooved channel in the tray.

### SOUNDS

- The operating sound may seem rather loud for 2 to 3 minutes when the unit is first turned on. This is the sound of the compressor's start-up and is normal.
- A soft, swishing noise can be heard immediately after the unit is turned on or off, and also during operation. This is the sound of the refrigerant flowing inside the unit.

### IF THE UNIT FAILS TO RECEIVE THE REMOTE CONTROL SIGNAL

- Check the remote control batteries. Replace if necessary.
- Try to send the signal again with the remote control pointed directly at the unit's receiver window.
- Check whether the remote control batteries are installed with the polarities properly aligned.

### FAULT CODES:

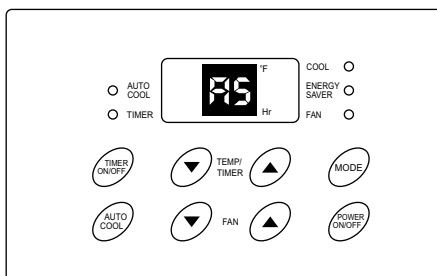

If the display reads "AS",  
a sensor has failed. Contact your  
Authorized SHARP Service Center.

# **SHARP**

**SHARP ELECTRONICS CORPORATION**

**Sharp Plaza, Mahwah, New Jersey 07495-1163**

**SHARP CORPORATION**

**Osaka, Japan**

Printed in China  
66129902992